

STRATIGRAFIE SISTEMI ELOWEB

SISTEMA ELOWEB STRONG 'STANDARD' PANNELLO ISOLANTE TERMOFORMATO PASSO 50 mm

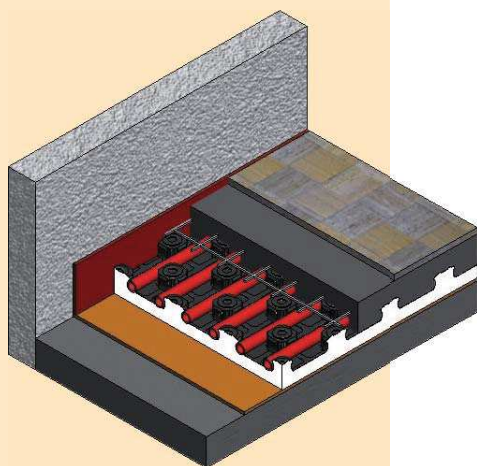

SISTEMA ELOWEB STRONG 'SNOW' PANNELLO ISOLANTE TERMOFORMATO DOPPIA DENSITA' PASSO 50 mm

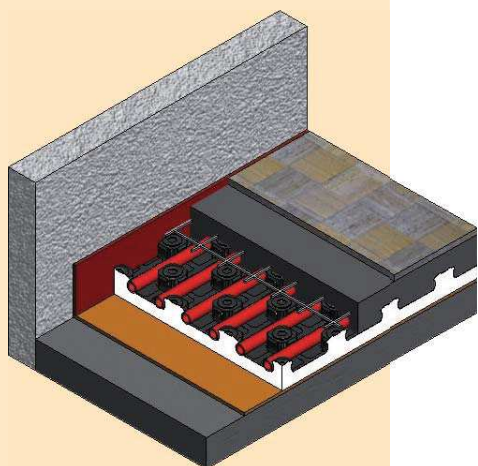

ELEMENTI DI BASE DEL SISTEMA:



PANNELLO ISOLANTE

17TAPTF50...P



TUBAZIONE

17TPEXA17... - 17TPERT17...

17TMULTI16...



FASCIA PERIMETRALE

17TAFPE15008 - 17TAFPEL15006



GIUNTO DI DILATAZIONE

17TAFPEAD - 17TAFPEEXP

17TEXPJOPROF - 17TGUAINA 24



FISSAGGIO TUBO-PANNELLO

17TCLIP1620 - 17TCLIPONTE



MASSETTO CEMENTIZIO

17TADDTFLU10 - 17TFRPP6



RETE ANTIFESSURATIVA

17TRETEPP1 - 17TRMAF5502



FOGLIO PE ANTICONDENSA E/O ISOLANTE

ANTICALPESTIO

17TFPEAC - 17TAPDBPE...

ELEMENTI A CORREDO DEL SISTEMA:



CASSETTA PER COLLETTORE

17TC...



GRUPPO DI DISTRIBUZIONE

17TCNOBOX...



ADATTATORE TUBO/COLLETTORE

17TATP/TATM...



TESTINA TERMoeLETRICA

17TEV230/24...



REGOLAZIONE (PUNTO FISSO/CLIMATICA)

17TGRBOX... - 17CLIMA...

ELEMENTI DI BASE DEL SISTEMA:



PANNELLO ISOLANTE

17TAPTF50...PA



TUBAZIONE

17TPEXA17... - 17TPERT17...

17TMULTI16...



FASCIA PERIMETRALE

17TAFPE15008 - 17TAFPEL15006



GIUNTO DI DILATAZIONE

17TAFPEAD - 17TAFPEEXP

17TEXPJOPROF - 17TGUAINA 24



FISSAGGIO TUBO-PANNELLO

17TCLIP1620 - 17TCLIPONTE



MASSETTO CEMENTIZIO

17TADDTFLU10 - 17TFRPP6



RETE ANTIFESSURATIVA

17TRETEPP1 - 17TRMAF5502



FOGLIO PE ANTICONDENSA E/O ISOLANTE

ANTICALPESTIO

17TFPEAC - 17TAPDBPE...

ELEMENTI A CORREDO DEL SISTEMA:



CASSETTA PER COLLETTORE

17TC...



GRUPPO DI DISTRIBUZIONE

17TCNOBOX...



ADATTATORE TUBO/COLLETTORE

17TATP/TATM...



TESTINA TERMoeLETRICA

17TEV230/24...



REGOLAZIONE (PUNTO FISSO/CLIMATICA)

17TGRBOX... - 17CLIMA...



STRATIGRAFIE SISTEMI ELOWEB

SISTEMA ELOWEB STRONG 'BLACK' PANNELLO ISOLANTE TERMOFORMATO CON GRAFITE PASSO 50 mm

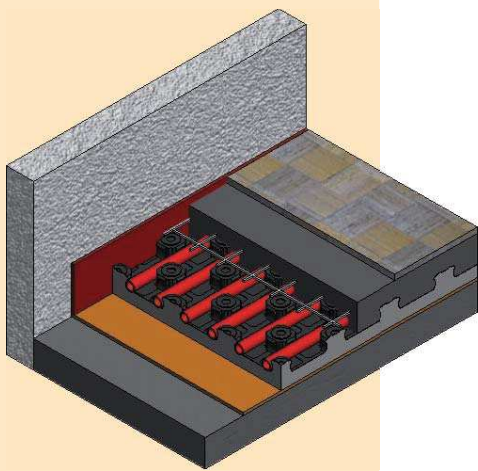

SISTEMA ELOWEB STRONG 'LORD BLACK' PANNELLO ISOLANTE TERMOFORMATO DOPPIA DENSITA' CON GRAFITE PASSO 50 mm

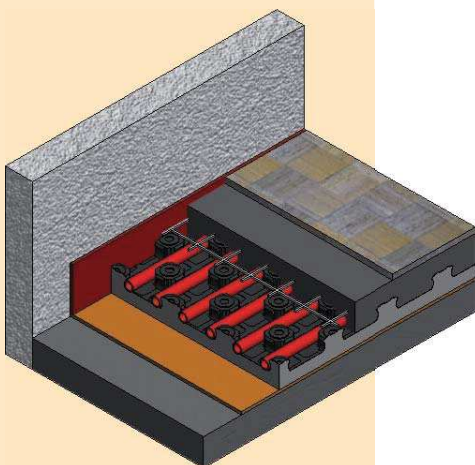

ELEMENTI DI BASE DEL SISTEMA:



PANNELLO ISOLANTE

17TAPTF50...PG



TUBAZIONE

17TPEXA17... - 17TPERT17...
17TMULTI16...



FASCIA PERIMETRALE

17TAFPE15008 - 17TAFPEL15006



GIUNTO DI DILATAZIONE

17TAFPEAD - 17TAFPEEXP
17TEXPJOPROF - 17TGUAINA 24



FISSAGGIO TUBO-PANNELLO

17TCLIP1620 - 17TCLIPONTE



MASSETTO CEMENTIZIO

17TADDTFLU10 - 17TFRPP6



RETE ANTIFESSURATIVA

17TRETEPP1 - 17TRMAF5502



FOGLIO PE ANTICONDENSA E/O ISOLANTE ANTICALPESTIO

17TFPEAC - 17TAPDBPE...

ELEMENTI A CORREDO DEL SISTEMA:



CASSETTA PER COLLETORE

17TC...



GRUPPO DI DISTRIBUZIONE

17TCNOBOX...



ADATTATORE TUBO/COLLETORE

17TATP/TATM...



TESTINA TERMoeLETRICA

17TEV230/24...



REGOLAZIONE (PUNTO FISSO/CLIMATICA)

17TGRBOX... - 17CLIMA...

ELEMENTI DI BASE DEL SISTEMA:



PANNELLO ISOLANTE

17TAPTF50...PAG



TUBAZIONE

17TPEXA17... - 17TPERT17...
17TMULTI16...



FASCIA PERIMETRALE

17TAFPE15008 - 17TAFPEL15006



GIUNTO DI DILATAZIONE

17TAFPEAD - 17TAFPEEXP
17TEXPJOPROF - 17TGUAINA 24



FISSAGGIO TUBO-PANNELLO

17TCLIP1620 - 17TCLIPONTE



MASSETTO CEMENTIZIO

17TADDTFLU10 - 17TFRPP6



RETE ANTIFESSURATIVA

17TRETEPP1 - 17TRMAF5502



FOGLIO PE ANTICONDENSA E/O ISOLANTE ANTICALPESTIO

17TFPEAC - 17TAPDBPE...

ELEMENTI A CORREDO DEL SISTEMA:



CASSETTA PER COLLETORE

17TC...



GRUPPO DI DISTRIBUZIONE

17TCNOBOX...



ADATTATORE TUBO/COLLETORE

17TATP/TATM...



TESTINA TERMoeLETRICA

17TEV230/24...



REGOLAZIONE (PUNTO FISSO/CLIMATICA)

17TGRBOX... - 17CLIMA...

STRATIGRAFIE SISTEMI ELOWEB

SISTEMA ELOWEB 50

PANNELLO ISOLANTE
SAGOMATO
PASSO 50 mm

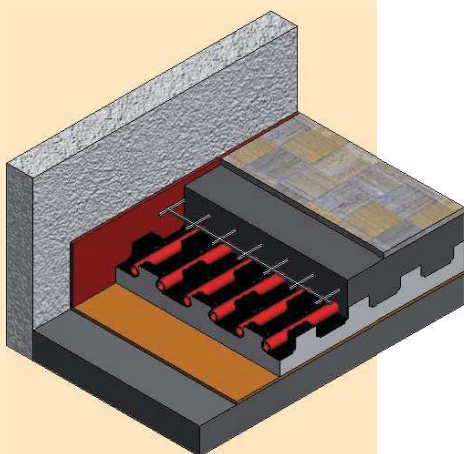

SISTEMA ELOWEB 75

PANNELLO ISOLANTE
SAGOMATO
PASSO 75 mm

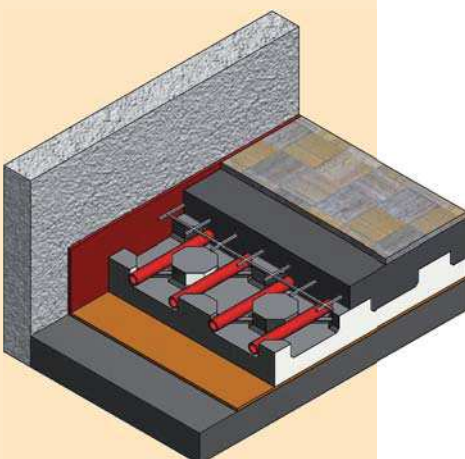

ELEMENTI DI BASE DEL SISTEMA:



PANNELLO ISOLANTE

17TAP5PE...



TUBAZIONE

17TPEXA17... - 17TPERT17...
17TMULT16...



FASCIA PERIMETRALE

17TAFPE15008 - 17TAFPEL15006



GIUNTO DI DILATAZIONE

17TAFPEAD - 17TAFPEEXP
17TEXPJOPROF - 17TGUAINA 24



FISSAGGIO TUBO-PANNELLO

17TCLIP1620 - 17TCLIPONTE



MASSETTO CEMENTIZIO

17TADDTFLU10 - 17TFBRPP6



RETE ANTIFESSURATIVA

17TRETEPP1 - 17TRMAF5502



FOGLIO PE ANTICONDENSA E/O ISOLANTE ANTICALPESTIO

17TFPEAC - 17TAPDBPE...

ELEMENTI A CORREDO DEL SISTEMA:



CASSETTA PER COLLETTORE

17TC...



GRUPPO DI DISTRIBUZIONE

17TCNOBOX...



ADATTATORE TUBO/COLLETTORE

17TATP/TATM...



TESTINA TERMOELETTRICA

17TEV230/24...



REGOLAZIONE (PUNTO FISSO/CLIMATICA)

17TGRBOX... - 17CLIMA...

ELEMENTI DI BASE DEL SISTEMA:



PANNELLO ISOLANTE

17TAP75PE...



TUBAZIONE

17TPEXA17... - 17TPERT17...
17TMULT16...



FASCIA PERIMETRALE

17TAFPE15008 - 17TAFPEL15006



GIUNTO DI DILATAZIONE

17TAFPEAD - 17TAFPEEXP
17TEXPJOPROF - 17TGUAINA 24



FISSAGGIO TUBO-PANNELLO

17TCLIP1620 - 17TCLIPONTE



MASSETTO CEMENTIZIO

17TADDTFLU10 - 17TFBRPP6



RETE ANTIFESSURATIVA

17TRETEPP1 - 17TRMAF5502



FOGLIO PE ANTICONDENSA E/O ISOLANTE ANTICALPESTIO

17TFPEAC - 17TAPDBPE...

ELEMENTI A CORREDO DEL SISTEMA:



CASSETTA PER COLLETTORE

17TC...



GRUPPO DI DISTRIBUZIONE

17TCNOBOX...



ADATTATORE TUBO/COLLETTORE

17TATP/TATM...



TESTINA TERMOELETTRICA

17TEV230/24...



REGOLAZIONE (PUNTO FISSO/CLIMATICA)

17TGRBOX... - 17CLIMA...



STRATIGRAFIE SISTEMI ELOWEB

SISTEMA ELOWEB ROLL

PANNELLO ISOLANTE PIANO
IN ROTOLO

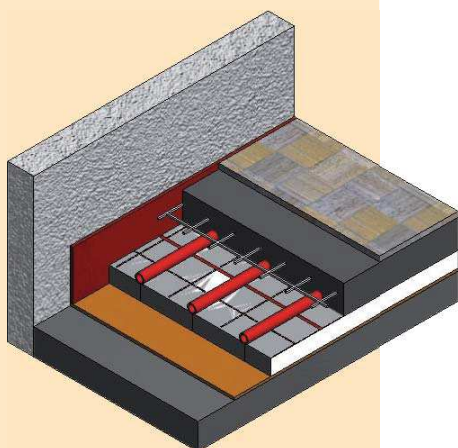

SISTEMA ELOWEB PUR

PANNELLO ISOLANTE
PIANO IN PUR

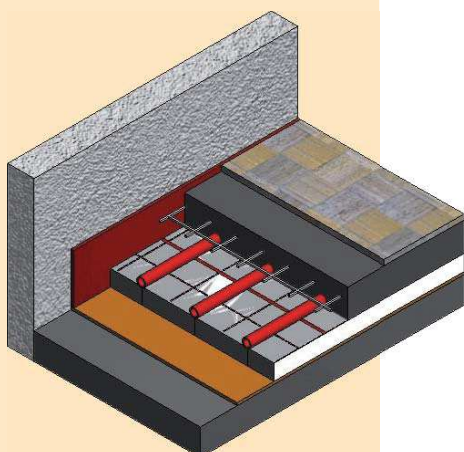

ELEMENTI DI BASE DEL SISTEMA:

-  **PANNELLO ISOLANTE**
17TROLL...
-  **TUBAZIONE**
17TPEXA17... - 17TPERT17...
17TMULTI16...
-  **FASCIA PERIMETRALE**
17TAFPE15008 - 17TAFPEL15006
-  **GIUNTO DI DILATAZIONE**
17TAFPEAD - 17TAFPEEXP
17TEXPJOPROF - 17TGUAINA 24
-  **FISSAGGIO TUBO-PANNELLO**
17TCLIP1620 - 17TCLIPRETE
-  **MASSETTO CEMENTIZIO**
17TADDTFLU10 - 17TFBRPP6
-  **RETE ANTIFESSURATIVA**
17TRETEPP1 - 17TRMAF5502
17TRMAF1003
-  **FOGLIO PE ANTICONDENSA E/O ISOLANTE
ANTICALPESTIO**
17TFPEAC - 17TAPDBPE...

ELEMENTI A CORREDO DEL SISTEMA:

-  **CASSETTA PER COLLETTORE**
17TC...
-  **GRUPPO DI DISTRIBUZIONE**
17TCNOBOX...
-  **ADATTATORE TUBO/COLLETTORE**
17TATP/TATM...
-  **TESTINA TERMoeLETRICA**
17TEV230/24...
-  **REGOLAZIONE (PUNTO FISSO/CLIMATICA)**
17TGRBOX... - 17CLIMA...

ELEMENTI DI BASE DEL SISTEMA:

-  **PANNELLO ISOLANTE**
17TAPUR...
-  **TUBAZIONE**
17TPEXA17... - 17TPERT17...
17TMULTI16...
-  **FASCIA PERIMETRALE**
17TAFPE15008 - 17TAFPEL15006
-  **GIUNTO DI DILATAZIONE**
17TAFPEAD - 17TAFPEEXP
17TEXPJOPROF - 17TGUAINA 24
-  **FISSAGGIO TUBO-PANNELLO**
17TCLIP1620 - 17TCLIPRETE
-  **MASSETTO CEMENTIZIO**
17TADDTFLU10 - 17TFBRPP6
-  **RETE ANTIFESSURATIVA**
17TRETEPP1 - 17TRMAF5502
17TRMAF101003
-  **FOGLIO PE ANTICONDENSA E/O ISOLANTE
ANTICALPESTIO**
17TAFPEAC - 17TAPDBPE...

ELEMENTI A CORREDO DEL SISTEMA:

-  **CASSETTA PER COLLETTORE**
17TC...
-  **GRUPPO DI DISTRIBUZIONE**
17TCNOBOX...
-  **ADATTATORE TUBO/COLLETTORE**
17TATP/TATM...
-  **TESTINA TERMoeLETRICA**
17TEV230/24...
-  **REGOLAZIONE (PUNTO FISSO/CLIMATICA)**
17TGRBOX... - 17CLIMA...

STRATIGRAFIE SISTEMI ELOWEB

SISTEMA ELOWEB LASTRA XPS STANDARD

PANNELLO ISOLANTE
PIANO IN XPS

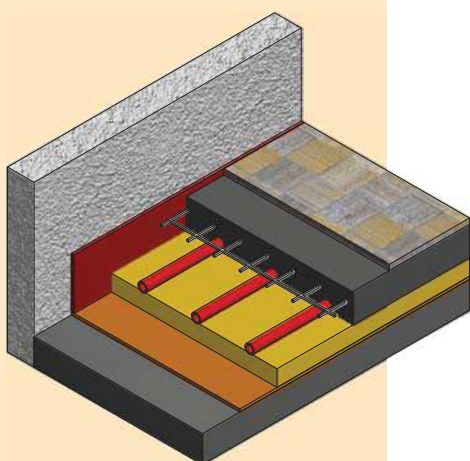

SISTEMA ELOWEB LASTRA XPS HP

PANNELLO ISOLANTE
PIANO IN XPS INDUSTRIALE

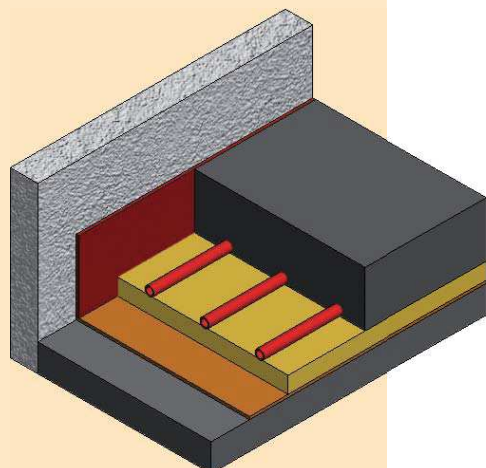

ELEMENTI DI BASE DEL SISTEMA:



PANNELLO ISOLANTE

17TLASTRAXPS...



TUBAZIONE

17TPEXA17... - 17TPERT17...

17TMULTI16...



FASCIA PERIMETRALE

17TAFPE15008 - 17TAFPEL15006



GIUNTO DI DILATAZIONE

17TAFPEAD - 17TAFPEEXP

17TEXPJOPROF - 17TGUAINA 24



FISSAGGIO TUBO-PANNELLO

17TCLIP1620 - 17TPROFU...



MASSETTO CEMENTIZIO

17TADDFLU10 - 17TFRPP6



RETE ANTIFESSURATIVA

17TRETPEP1 - 17TRMAF5502

17TRMAF01003



FOGLIO PE ANTICONDENSA E/O ISOLANTE

ANTICALPESTIO

17TAFPEAC - 17TAPDBPE...

ELEMENTI A CORREDO DEL SISTEMA:



CASSETTA PER COLLETTORE

17TC...



GRUPPO DI DISTRIBUZIONE

17TCNOBOX...



ADATTATORE TUBO/COLLETTORE

17TATP/TATM...



TESTINA TERMoeLETTRICA

17TEV230/24...



REGOLAZIONE (PUNTO FISSO/CLIMATICA)

17TGRBOX... - 17CLIMA...

ELEMENTI DI BASE DEL SISTEMA:



PANNELLO ISOLANTE

17TLASTRAXPS500/700...



TUBAZIONE

17TPEXA20/25... - 17TPERT20...



FASCIA PERIMETRALE

17TAFPE25010



GIUNTO DI DILATAZIONE

17TAFPEEXP - 17TEXPJOPROF

17TGUAINA 28



FISSAGGIO TUBO-PANNELLO

17TCLIP1620 - 17TPROFU...



FOGLIO PE ANTICONDENSA E/O ISOLANTE

ANTICALPESTIO

17TAFPEAC - 17TAPDBPE...

ELEMENTI A CORREDO DEL SISTEMA:



CASSETTA PER COLLETTORE

17TC...



GRUPPO DI DISTRIBUZIONE

17TCNOBOX...



ADATTATORE TUBO/COLLETTORE

17TATP/TATM...



TESTINA TERMoeLETTRICA

17TEV230/24...



REGOLAZIONE (PUNTO FISSO/CLIMATICA)

17TGRBOX... - 17CLIMA...



STRATIGRAFIE SISTEMI ELOWEB

SISTEMA ELOWEB MINIMAL

PANNELLO IN POLIPROPILENE
PER SISTEMA A BASSO SPESSORE

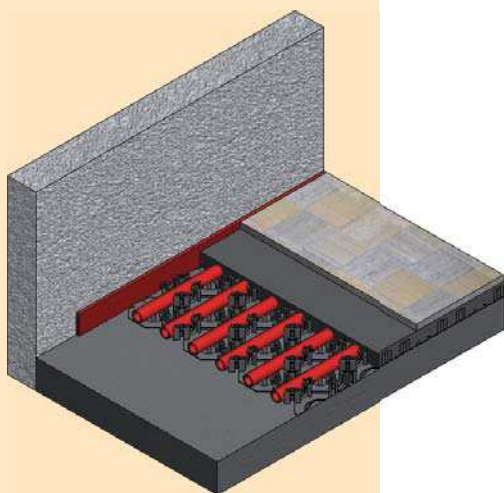

SISTEMA ELOWEB DRY 'ALUM'

PANNELLO ISOLANTE
IN EPS E ALLUMINIO
ER SISTEMA A SECCO
PASSO 150 mm

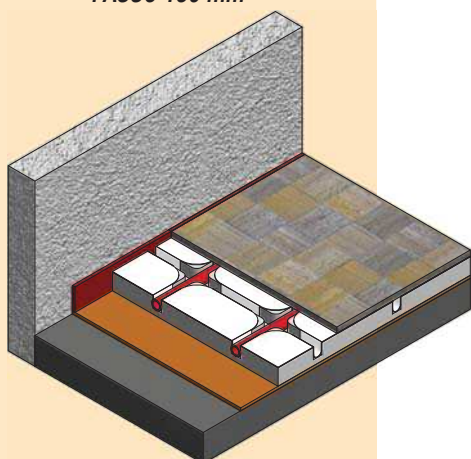

ELEMENTI DI BASE DEL SISTEMA:



PANNELLO ISOLANTE
17TAPMIN...



TUBAZIONE
17TPEXA17... - 17TPERT17...
17TMULTI16...



FASCIA PERIMETRALE
17TAFPE15008 - 17TAFPEL15006

ELEMENTI A CORREDO DEL SISTEMA:



CASSETTA PER COLLETTORE
17TC...



GRUPPO DI DISTRIBUZIONE
17TCNOBOX...



ADATTATORE TUBO/COLLETTORE
17TATP/TATM...



TESTINA TERMOELETTRICA
17TEV230/24...



REGOLAZIONE (PUNTO FISSO/CLIMATICA)
17TGRBOX... - 17CLIMA...

ELEMENTI DI BASE DEL SISTEMA:



PANNELLO ISOLANTE
17TAP28ALDRY...



TUBAZIONE
17TPEXA17... - 17TPERT17...
17TMULTI16...



FASCIA PERIMETRALE
17TAFPE15008 - 17TAFPEL15006



LASTRA IN ACCIAIO
17TCOVER/A



PANNELLO IN FIBROGESSO
alternativa a 17TCOVER/A



FOGLIO PE ANTICONDENSA E/O ISOLANTE
ANTICALPESTIO
17TAPFPEAC - 17TAPBPE...

ELEMENTI A CORREDO DEL SISTEMA:



CASSETTE COLLETTORI
17TC...



GRUPPO DI DISTRIBUZIONE
17TCNOBOX...



ADATTATORE TUBO/COLLETTORE
17TATP/TATM...



TESTINA TERMOELETTRICA
17TEV230/24...



REGOLAZIONE (PUNTO FISSO/CLIMATICA)
17TGRBOX... - 17CLIMA...

STRATIGRAFIE SISTEMI ELOWEB

SISTEMA ELOWEB DRY 'GYPSUM' PANNELLO ISOLANTE IN GESSO FIBRA PER SISTEMA A SECCO PASSO 150 mm

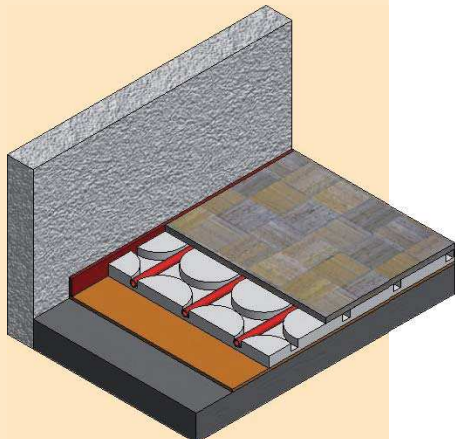

SISTEMA ELOWEB DRY 'LIGNUM' PANNELLO ISOLANTE IN FIBRA DI LEGNO PER SISTEMA A SECCO PASSO 150 mm

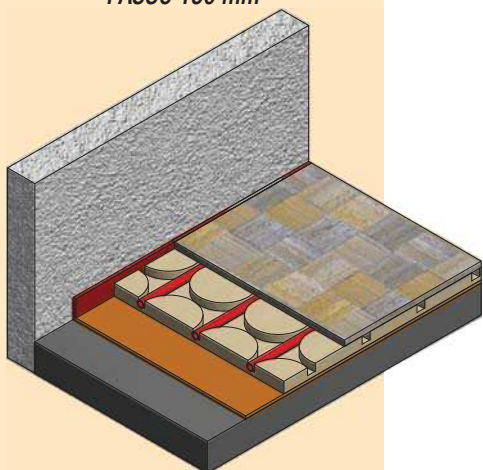

ELEMENTI DI BASE DEL SISTEMA:



PANNELLO ISOLANTE
17TAP18FG...



TUBAZIONE
17TPEXA10/12... - 17TPERT12...



FASCIA PERIMETRALE
17TAPFPE15008 - 17TAPFPEL15006



**FOGLIO PE ANTICONDENSA E/O ISOLANTE
ANTICALPESTIO**
17TAPFPEAC - 17TAPBPE...



**MATERIALI A COMPLETAMENTO DELLA
POSA**
17TEGYPRIMER/GLUEL/FILLER

ELEMENTI A CORREDO DEL SISTEMA:



CASSETTE COLLETTORI
17TC...



GRUPPO DI DISTRIBUZIONE
17TCNOBOX...



ADATTATORE TUBO/COLLETORE
17TATP/TATM...



TESTINA TERMoeLETTRICA
17TEV230/24...



REGOLAZIONE (PUNTO FISSO/CLIMATICA)
17TGRBOX... - 17CLIMA...

ELEMENTI DI BASE DEL SISTEMA:



PANNELLO ISOLANTE
17TAP40LG...



TUBAZIONE
17TMULTI16...



BARRA IN ALLUMINIO
17TBARCONDAL



FASCIA PERIMETRALE
17TELGF



LASTRA IN ACCIAIO
17TCOVER/A



PANNELLO IN FIBROGESSO
alternativa a 17TCOVER/A



**FOGLIO PE ANTICONDENSA E/O ISOLANTE
ANTICALPESTIO**
17TAPFPEAC - 17TAPDBPE...

ELEMENTI A CORREDO DEL SISTEMA:



CASSETTE COLLETTORI
17TC...



GRUPPO DI DISTRIBUZIONE
17TCNOBOX...



ADATTATORE TUBO/COLLETORE
17TATP3412A



TESTINA TERMoeLETTRICA
17TEV230/24...



REGOLAZIONE (PUNTO FISSO/CLIMATICA)
17TGRBOX... - 17CLIMA...



SCELTA DI UN PANNELLO IN UN CONTESTO ABITATIVO IN ACCORDO ALLA UNI EN1264

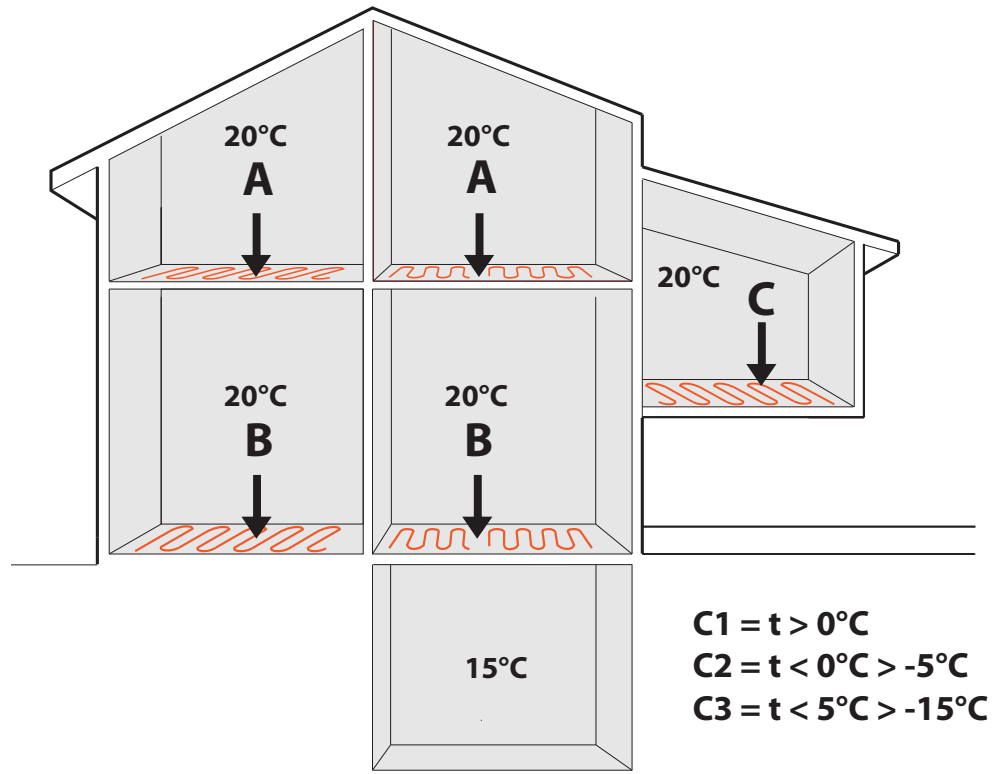

PANNELLO ISOLANTE

Il suo posizionamento riduce in modo sensibile le dispersioni di calore verso il basso e la scelta dello spessore è legata ai requisiti del D.Lgs 311 - inerente al rispetto dei valori di trasmittanza termica delle strutture orizzontali - e della norma UNI EN 1264-4 - relativa alla resistenza termica minima degli strati d'isolamento sottostanti l'impianto di riscaldamento a pavimento - entrambe sensibili al risparmio energetico.

Tipo	A	B	C1	C2	C3
Resistenza termica (m ² * K/W)	Ambiente sottostante riscaldato	Ambiente sottostante non riscaldato o riscaldato in modo non continuativo o direttamente sul suolo*	Temperatura dell'aria esterna sottostante		
			Temperatura esterna di progetto Td ≥ 0 °C	Temperatura esterna di progetto 0 °C > Td ≥ -5 °C	Temperatura esterna di progetto -5 °C > Td ≥ -15 °C
	0,75	1,25	1,25	1,50	2,00

* Con un livello di acque freatiche ≤ 5m, il valore dovrebbe essere aumentato



Tipologia di un Sistema Eloweb